

Diritti riservati All rights reserved

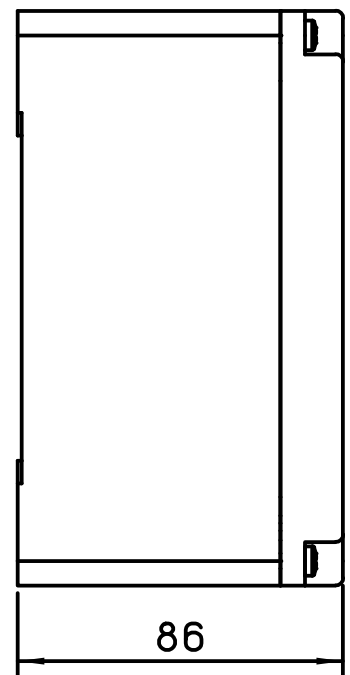
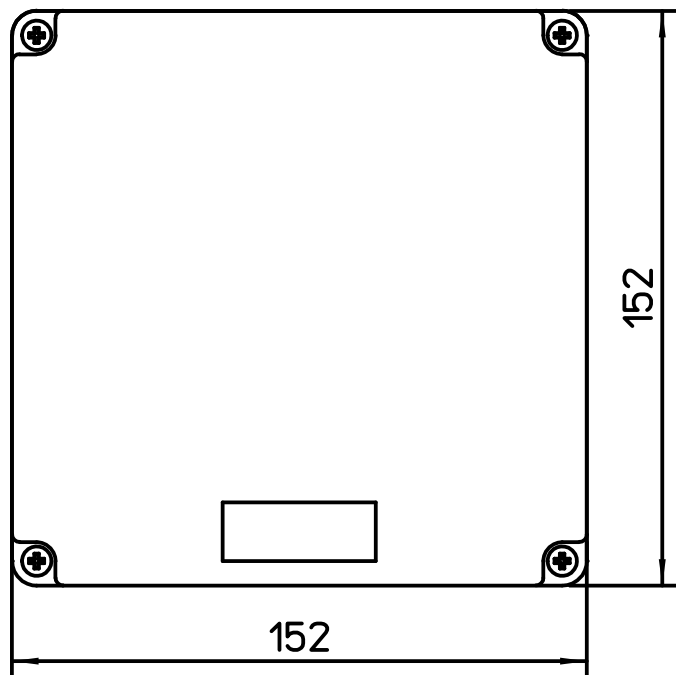
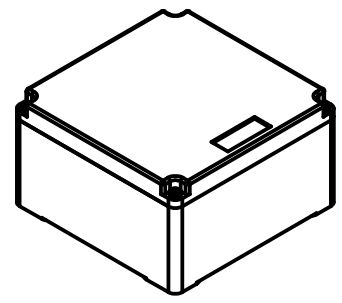
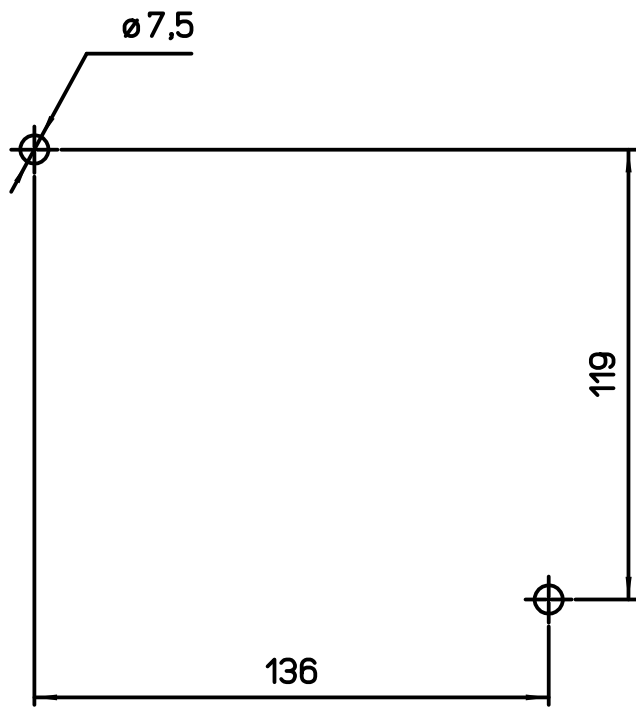

dimensions in mm	AP 1515	Scale	
Date 21/07/16	Box 152x152x86	1:2	
Sign. F.Zaffora			